

Varenummer: 0106034
 Beskrivelse: Seeger låsering JV 18

Mål

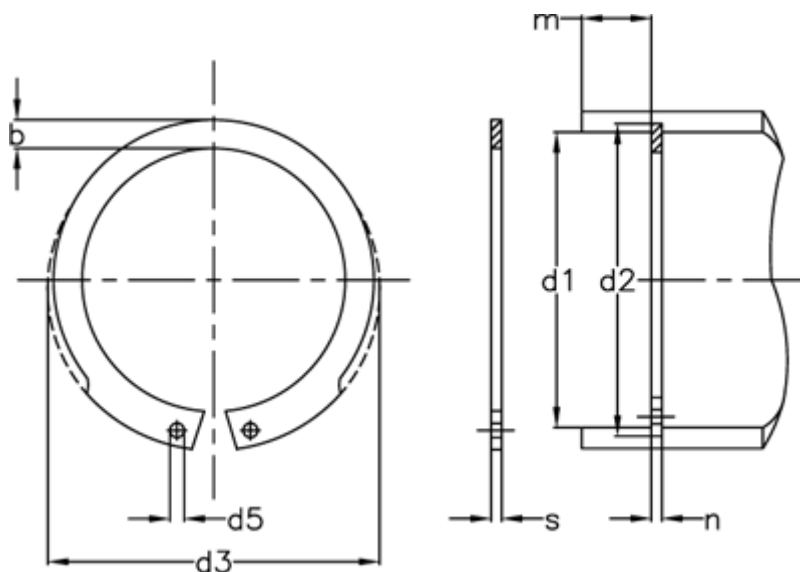

AN mm ²	= 14	FRg kN	= 3.0	Tang	= ZGJ-1
b	= 2.2	FR kN	= 6.3	tol	= -0.06
Betegnelse	= JV 18	g	= 1.0	tol	= +0,42-0,13
d1	= 18	K kN-mm	= 20.4	tol	= +0,15
d2	= 19.0	m min	= 1.10	tol	= 0.1
d3	= 19.5	Nominel træk	= 1.5	vægt kg/1000	= 0.62
d5 min	= 1.3	s	= 1.00		
FN kN	= 1.78	t	= 0.50		